

GENERAL PURPOSE BALL VALVE

Lever Handle FI X FI

Product Specifications

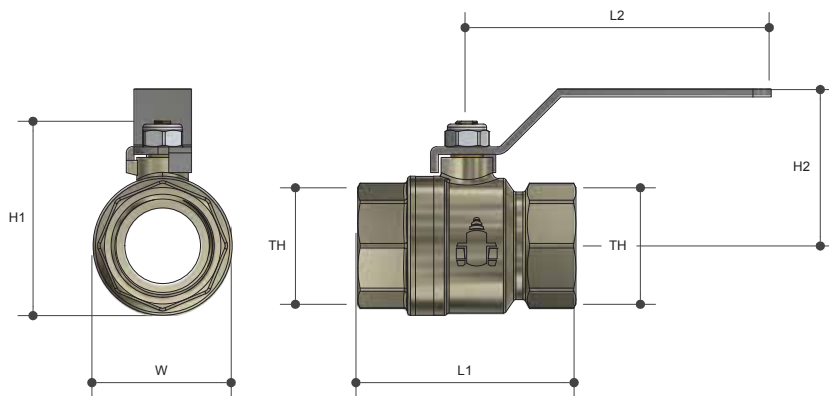

Specifications

Working temperature 1°C to 120°C

Maximum pressure rating 1600kPa

Features

Available in sizes 15mm (1/2") to 100mm (4")

Full Bore

100% pressure tested

Blow proof spindle

Stainless steel handle

Sizing Chart (MM)

	SIZE	H1	H2	L1	L2	W	TH
BV11	6MM	46	88	47	44	20	Rp 1/4"
BV12	10MM	50	88	47	44	20	Rp 3/8"
BV01	15MM	51	90	51	45	25	Rp 1/2"
BV02	20MM	58	101	55	48	30	Rp 3/4"
BV03	25MM	72	122	64	62	38	Rp 1"
BV04	32MM	81	122	80	70	45	Rp 1 1/4"
BV05	40MM	90	140	92	77	53	Rp 1 1/2"
BV06	50MM	110	140	108	85	67	Rp 2"
BV07	65MM	137	232	143	110	82	Rp 2 1/2"
BV08	80MM	163	232	187	122	95	Rp 3"
BV09	100MM	187	226	193	150	160	Rp 2 1/2"

Material Chart

Part	Material
Body	Brass
Seal	PTFE
Ball (15-40MM)	Brass
Ball (50MM)	Stainless Steel
Spindle (15-40MM)	Brass
Spindle (50MM)	Stainless Steel
Bonnet	Brass
O Ring	HNBR
Handle	Stainless Steel
Lock Nut	Stainless Steel

For more information on Logi Valve, contact:
Austworld 15 Activity Crescent, Molendinar, Queensland 4214 Australia

P. 1300 780 430 F. 1300 780 441 E. info@austworld.com.au

Austworld Pty Ltd. All rights reserved 2018. Austworld and Logi Valve are registered trade mark belonging to Austworld Pty Ltd.

